

Power Operational Amplifiers

FEATURES

- HIGH SLEW RATE — 200V/ μ s
- FAST SETTLING TIME — .1% in 1 μ s (PA84S)
- FULLY PROTECTED INPUT — Up to \pm 150V
- LOW BIAS CURRENT, LOW NOISE — FET Input
- WIDE SUPPLY RANGE — \pm 15V to \pm 150V



8-PIN TO-3
PACKAGE STYLE CE

APPLICATIONS

- HIGH VOLTAGE INSTRUMENTATION
- ELECTROSTATIC TRANSDUCERS & DEFLECTION
- PROGRAMMABLE POWER SUPPLIES UP TO 290V
- ANALOG SIMULATORS

DESCRIPTION

The PA84 is a high voltage operational amplifier designed for output voltage swings up to \pm 145V with a dual supply or 290V with a single supply. Two versions are available. The new PA84S, fast settling amplifier can absorb differential input overvoltages up to \pm 50V while the established PA84 and PA84A can handle differential input overvoltages of up to \pm 300V. Both versions are protected against common mode transients and overvoltages up to the supply rails. High accuracy is achieved with a cascode input circuit configuration. All internal biasing is referenced to a zener diode fed by a FET constant current source. As a result, the PA84 features an unprecedented supply range and excellent supply rejection. The output stage is biased-on for linear operation. External phase compensation allows for user flexibility in obtaining the maximum slew rate. Fixed current limits protect these amplifiers against shorts to common at supply voltages up to 150V. For operation into inductive loads, two external flyback pulse protection diodes are recommended. However, a heatsink may be necessary to maintain the proper case temperature under normal operating conditions.

This hybrid integrated circuit utilizes a beryllia (BeO) substrate, thick film resistors, ceramic capacitors and semiconductor chips to maximize reliability, minimize size and give top performance. Ultrasonically bonded aluminum wires provide reliable interconnections at all operating temperatures. The 8-pin TO-3 package is hermetically sealed and electrically isolated. The use of compressible thermal isolation washers and/or improper mounting torque will void the product warranty. Please see "General Operating Considerations".

EXTERNAL CONNECTION

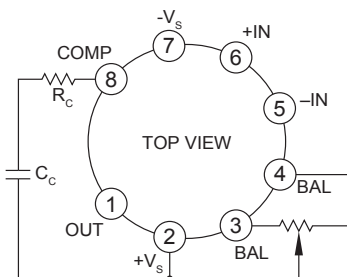

PHASE COMPENSATION

GAIN	C _c	R _c
1	10nF	200 Ω
10	500pF	2K Ω
100	50pF	20K Ω
1000	none	none

NOTES:

1. Phase Compensation required for safe operation.
2. Input offset trimpot optional. Recommended value 100K Ω .

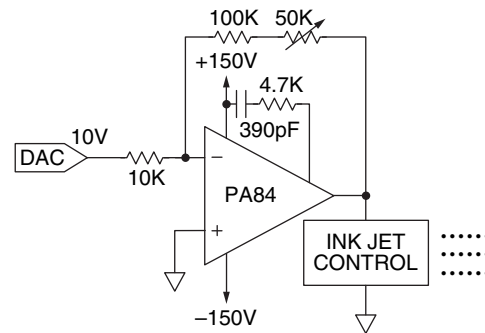

TYPICAL APPLICATION

The PA84 is ideally suited to driving ink jet control units (often a piezo electric device) which require precise pulse shape control to deposit crisp clear date or lot code information on product containers. The external compensation network has been optimized to match the gain setting of the circuit and the complex impedance of the ink jet control unit. The combination of speed and high voltage capabilities of the PA84 form ink droplets of uniform volume at high production rates to enhance the value of the printer.

EQUIVALENT SCHEMATIC

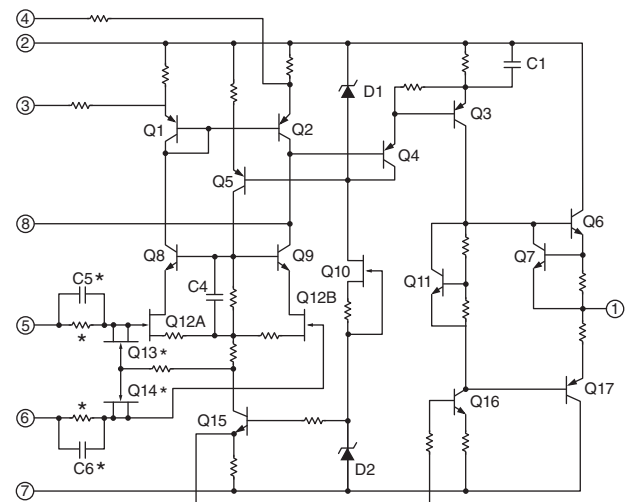

*Not included in PA84S.

ABSOLUTE MAXIMUM RATINGS

SUPPLY VOLTAGE, +V _S to -V _S	300V
OUTPUT CURRENT, within SOA	Internally Limited
POWER DISSIPATION, internal at T _C = 25°C ²	17.5W
INPUT VOLTAGE, differential PA84/PA84A ¹	±300V
INPUT VOLTAGE, differential PA84S	±50V
INPUT VOLTAGE, common mode ¹	±V _S
TEMPERATURE, pins for 10s max (solder)	350°C
TEMPERATURE, junction ²	175°C
TEMPERATURE RANGE, storage	-65 to +150°C
OPERATING TEMPERATURE RANGE, case	-55 to +125°C

SPECIFICATIONS

PARAMETER	TEST CONDITIONS ³	PA84/PA84S			PA84A			UNITS
		MIN	TYP	MAX	MIN	TYP	MAX	
INPUT								
OFFSET VOLTAGE, initial	T _C = 25°C		±1.5	±3		±.5	±1	mV
OFFSET VOLTAGE, vs. temperature	T _C = -25° to +85°C		±10	±25		±.5	±10	μV/°C
OFFSET VOLTAGE, vs. supply	T _C = 25°C		±.5			±.2		μV/V
OFFSET VOLTAGE, vs. time	T _C = 25°C		±75			*		μV/√kh
BIAS CURRENT, initial ⁴	T _C = 25°C		5	50		3	10	pA
BIAS CURRENT, vs. supply	T _C = 25°C		.01			*		pA/V
OFFSET CURRENT, initial ⁴	T _C = 25°C		±2.5	±50		±1.5	±10	pA
OFFSET CURRENT, vs. supply	T _C = 25°C		±.01			*		pA/V
INPUT IMPEDANCE, DC	T _C = 25°C		10 ¹¹			*		Ω
INPUT CAPACITANCE	T _C = -25° to +85°C		6			*		pF
COMMON MODE VOLTAGE RANGE ⁵	T _C = -25° to +85°C	±V _S -10	±V _S -8.5		*	*		V
COMMON MODE REJECTION, DC	T _C = -25° to +85°C		130			*		dB
GAIN								
OPEN LOOP GAIN at 10Hz	T _C = 25°C, R _L = ∞					*		dB
OPEN LOOP GAIN at 10Hz.	T _C = 25°C, R _L = 3.5KΩ	100	118		*	*		dB
GAIN BANDWIDTH PRODUCT @ 1MHz	T _C = 25°C, R _L = 3.5KΩ, R _C = 20KΩ		75			*		MHz
POWER BANDWIDTH, high gain	T _C = 25°C, R _L = 3.5KΩ, R _C = 20KΩ		250		180	*		kHz
POWER BANDWIDTH, low gain	T _C = 25°C, R _L = 3.5KΩ, R _C = 20KΩ		120			*		kHz
OUTPUT								
VOLTAGE SWING ⁵	T _C = 25°C, I _O = ±40mA		±V _S -7	±V _S -3		*		V
VOLTAGE SWING ⁵	T _C = -25° to +85°C, I _O = ±15mA		±V _S -5	±V _S -2		*		V
CURRENT, peak	T _C = 25°C		40			*		mA
CURRENT, short circuit	T _C = 25°C			50		*		mA
SLEW RATE, high gain	T _C = 25°C, R _L = 3.5KΩ, R _C = 20KΩ			200	150	*		V/μs
SLEW RATE, low gain	T _C = 25°C, R _L = 3.5KΩ, R _C = 2KΩ			125		*		V/μs
SETTLING TIME .01% at gain = 100	T _C = 25°C, R _L = 3.5KΩ			2				μs
SETTLING TIME .1% at gain = 100	R _C = 20KΩ, V _{IN} = 2V step			1				μs
SETTLING TIME .01% at gain = 100	T _C = 25°C, R _L = 3.5KΩ			20		20		μs
SETTLING TIME .1% at gain = 100	R _C = 20KΩ, V _{IN} = 2V step			12		12		μs
POWER SUPPLY								
VOLTAGE	T _C = -55°C to +125°C	±15		±150	*		*	V
CURRENT, quiescent	T _C = 25°C		5.5	7.5		*	*	mA
THERMAL								
RESISTANCE, AC, junction to case ⁶	T _C = -55°C to +125°C, F > 60Hz		4.26			*		°C/W
RESISTANCE, DC, junction to case	T _C = -55°C to +125°C, F < 60Hz		6.22	8.57		*	*	°C/W
RESISTANCE, case to air	T _C = -55°C to +125°C		30			*		°C/W
TEMPERATURE RANGE, case	Meets full range specifications	-25		+85	*		*	°C

- NOTES: * The specification of PA84A is identical to the specification for PA84/PA84S in applicable column to the left.
- Signal slew rates at pins 5 and 6 must be limited to less than 1V/ns to avoid damage. When faster waveforms are unavoidable, resistors in series with those pins, limiting current to 150mA will protect the amplifier from damage.
 - Long term operation at the maximum junction temperature will result in reduced product life. Derate internal power dissipation to achieve high MTTF.
 - The power supply voltage for all tests is ±150V, unless otherwise noted as a test condition.
 - Doubles for every 10°C of temperature increase.
 - +V_S and -V_S denote the positive and negative power supply rail respectively.
 - Rating applies if the output current alternates between both output transistors at a rate faster than 60Hz.

CAUTION The internal substrate contains beryllia (BeO). Do not break the seal. If accidentally broken, do not crush, machine, or subject to temperatures in excess of 850°C to avoid generating toxic fumes.

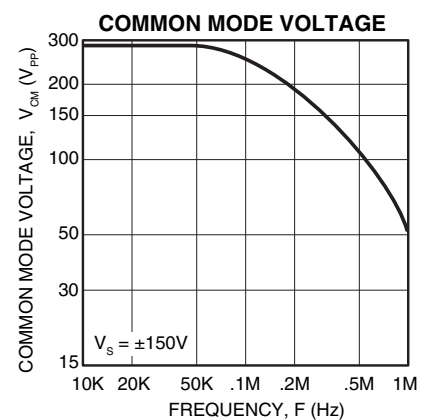
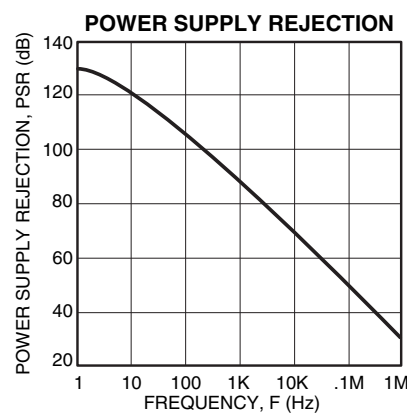
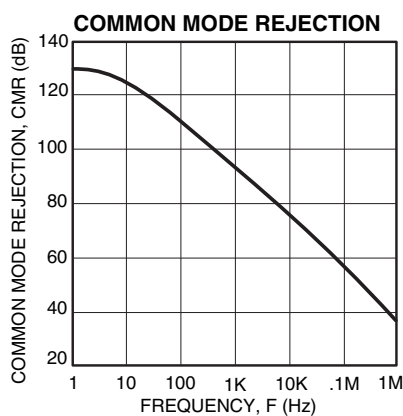
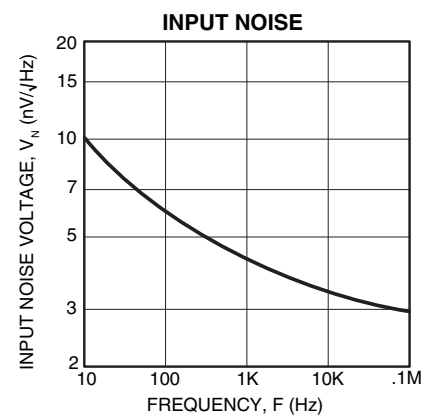
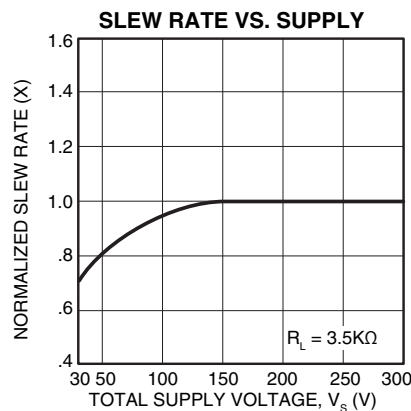
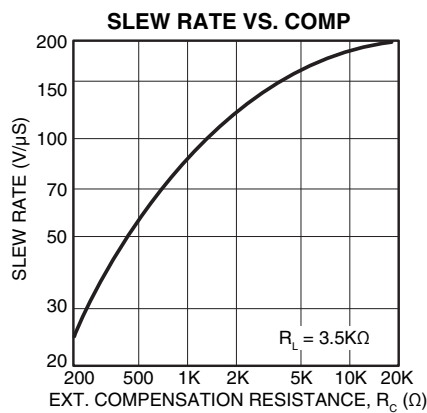
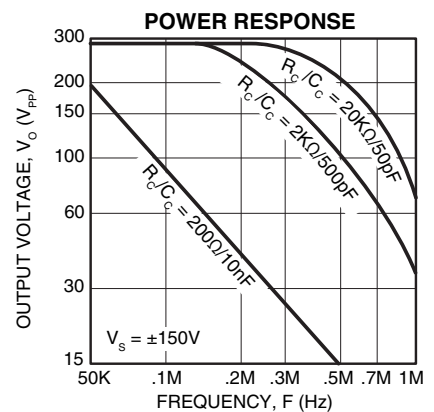
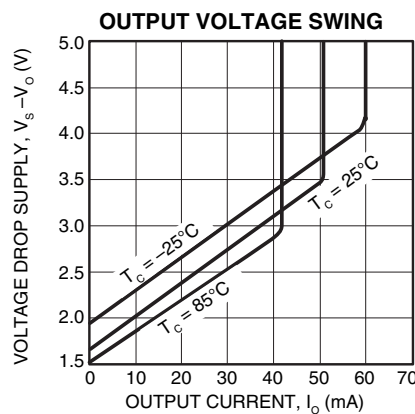
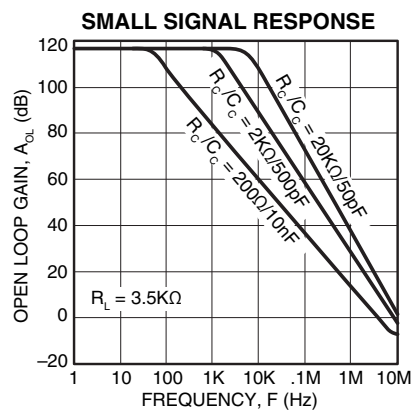
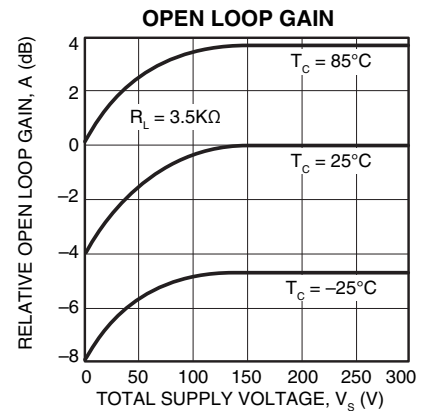
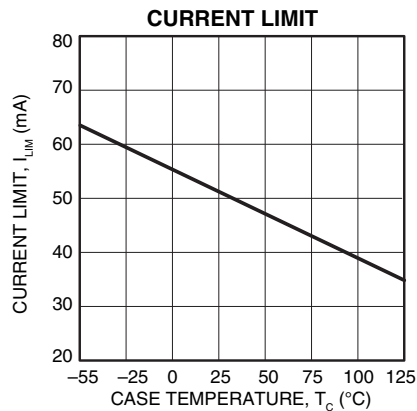
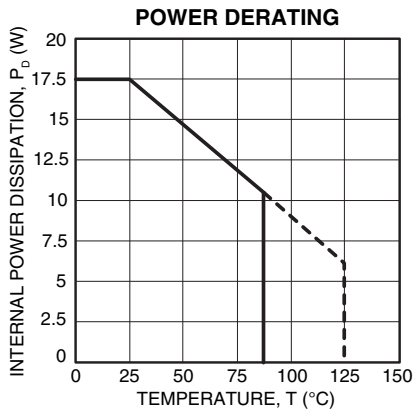

GENERAL

Please read Application Note 1 "General Operating Considerations" which covers stability, supplies, heat sinking, mounting, current limit, SOA interpretation, and specification interpretation. Visit www.apexanalog.com for design tools that help automate tasks such as calculations for stability, internal power dissipation, current limit and heat sink selection. The "Application Notes" and "Technical Seminar" sections contain a wealth of information on specific types of applications. Package outlines, heat sinks, mounting hardware and other accessories are located in the "Packages and Accessories" section. Evaluation Kits are available for most Apex Microtechnology product models, consult the "Evaluation Kit" section for details. For the most current version of all Apex Microtechnology product data sheets, visit www.apexanalog.com.

SAFE OPERATING AREA (SOA)

The bipolar output stage of this high voltage operational amplifier has two output limitations:

1. The internal current limit which limits maximum available output current.
2. The second breakdown effect, which occurs whenever the simultaneous collector current and collector-emitter voltage exceeds specified limits.

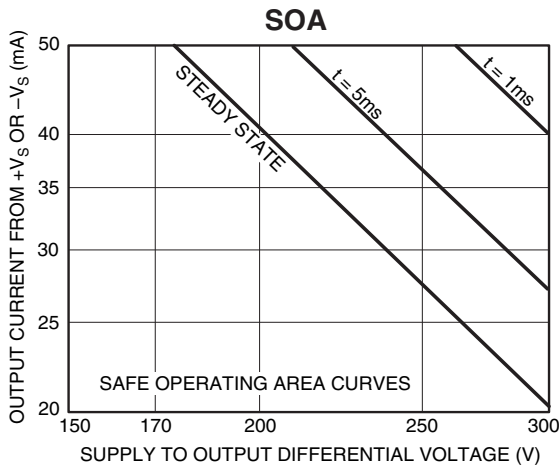

The SOA curves combine the effect of these limits. For a given application, the direction and magnitude of the output current should be calculated or measured and checked against the SOA curves. This is simple for resistive loads but more complex for reactive and EMF generating loads. However, the following guidelines may save extensive analytical efforts:

1. The following capacitive and inductive loads are safe:

$\pm V_s$	C(MAX)	L(MAX)
150V	1.2 μ F	.7H
125V	6.0 μ F	25H
100V	12 μ F	90H
75V	ALL	ALL
2. Short circuits to ground are safe with dual supplies up to $\pm 150V$ or single supplies up to 150V.
3. Short circuits to the supply rails are safe with total supply voltages up to 150V (i.e. $\pm 75V$).

OUTPUT PROTECTION

Two external diodes as shown in Figure 1, are required to protect these amplifiers against flyback (kickback) pulses exceeding the supply voltages of the amplifier when driving inductive loads. For component selection, these external diodes must be very quick, such as ultra fast recovery diodes with no more than 200 nanoseconds of reverse recovery time. Be sure the diode voltage rating is greater than the total of both supplies. The diode will turn on to divert the flyback energy into the supply rails thus protecting the output transistors from destruction due to reverse bias.

FIGURE 1. PROTECTIVE, INDUCTIVE LOAD

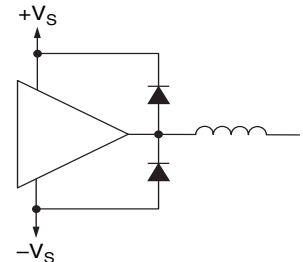

A note of caution about the supply. The energy of the flyback pulse must be absorbed by the power supply. As a result, a transient will be superimposed on the supply voltage, the magnitude of the transient being a function of its transient impedance and current sinking capability. If the supply voltage plus transient exceeds the maximum supply rating or if the AC impedance of the supply is unknown, it is best to clamp the output and the supply with a zener diode to absorb the transient.

STABILITY

Due to its large bandwidth the PA84 is more likely to oscillate than lower bandwidth Power Operational Amplifiers such as the PA83 or PA08. To prevent oscillations, a reasonable phase margin must be maintained by:

1. Selection of the proper phase compensation capacitor and resistor. Use the values given in the table under external connections and interpolate if necessary. The phase margin can be increased by using a large capacitor and a smaller resistor than the slew rate optimized values listed in the table. The compensation capacitor may be connected to common (in lieu of +Vs) if the positive supply is properly bypassed to common. Because the voltage at pin 8 is only a few volts below the positive supply, this ground connection requires the use of a high voltage capacitor.
2. Keeping the external sumpoint stray capacitance to ground at a minimum and the sumpoint load resistance (input and feedback resistors in parallel) below 500 Ω . Larger sumpoint load resistance can be used with increased phase compensation (see 1 above).
3. Connecting the amplifier case to a local AC common thus preventing it from acting as an antenna.

NEED TECHNICAL HELP? CONTACT APEX SUPPORT!

For all Apex Microtechnology product questions and inquiries, call toll free 800-546-2739 in North America.

For inquiries via email, please contact apex.support@apexanalog.com.

International customers can also request support by contacting their local Apex Microtechnology Sales Representative.

To find the one nearest to you, go to www.apexanalog.com

IMPORTANT NOTICE

Apex Microtechnology, Inc. has made every effort to insure the accuracy of the content contained in this document. However, the information is subject to change without notice and is provided "AS IS" without warranty of any kind (expressed or implied). Apex Microtechnology reserves the right to make changes without further notice to any specifications or products mentioned herein to improve reliability. This document is the property of Apex Microtechnology and by furnishing this information, Apex Microtechnology grants no license, expressed or implied under any patents, mask work rights, copyrights, trademarks, trade secrets or other intellectual property rights. Apex Microtechnology owns the copyrights associated with the information contained herein and gives consent for copies to be made of the information only for use within your organization with respect to Apex Microtechnology integrated circuits or other products of Apex Microtechnology. This consent does not extend to other copying such as copying for general distribution, advertising or promotional purposes, or for creating any work for resale.

APEX MICROTECHNOLOGY PRODUCTS ARE NOT DESIGNED, AUTHORIZED OR WARRANTED TO BE SUITABLE FOR USE IN PRODUCTS USED FOR LIFE SUPPORT, AUTOMOTIVE SAFETY, SECURITY DEVICES, OR OTHER CRITICAL APPLICATIONS. PRODUCTS IN SUCH APPLICATIONS ARE UNDERSTOOD TO BE FULLY AT THE CUSTOMER OR THE CUSTOMER'S RISK.

Apex Microtechnology, Apex and Apex Precision Power are trademarks of Apex Microtechnology, Inc. All other corporate names noted herein may be trademarks of their respective holders.