

Power Operational Amplifier



FEATURES

- 200 °C Version of PA12
- Output Current at 200°C — ±1A
- Full Specifications — -25°C to +125°C
- Wide Supply Range — ±10 to ±45V
- Current Foldover Protection
- Excellent Linearity — Class A/B Output



APPLICATIONS

- Motor, Valve and Actuator Control
- Power Transducers up to 100 kHz
- Programmable Power Supplies up to 80V
- Transmission Line Driver

DESCRIPTION

The PA12H is a low cost, high temperature Power Op Amp made especially for short term use in extreme environmental situations such as down hole instrumentation. The amplifier can power mechanical or electronic transducers and can drive the long transmission lines associated with these applications.

The PA12H, based on the standard PA12's very high power level, leaves a six watt capability after being derated for operation at a case temperature of 200°C. To meet the high temperature requirements for up to 200 hours, polyimid has replaced the standard epoxy for attaching the small signal devices.

These hybrid integrated circuits utilize thick film conductors, ceramic capacitors and silicon semiconductors to maximize reliability, minimize size and give top performance. Ultrasonically bonded aluminum wires provide reliable interconnections at all operating temperatures. The 8-pin TO-3 package (see Package Outlines) is hermetically sealed and isolated. The use of compressible thermal washers and/or improper mounting torque will void the product warranty. Please see "General Operating Considerations".

Figure 1: Calculated Life Expectancy

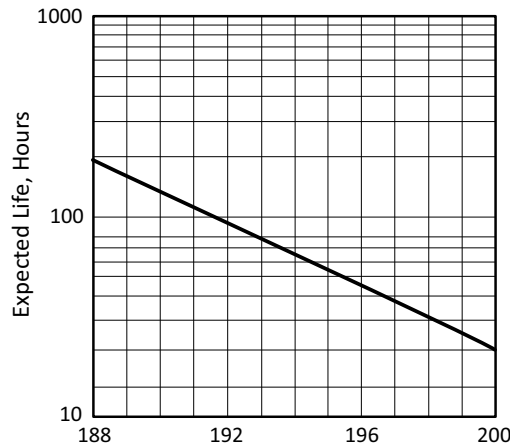

PINOUT AND DESCRIPTION TABLE

Figure 2: External Connections

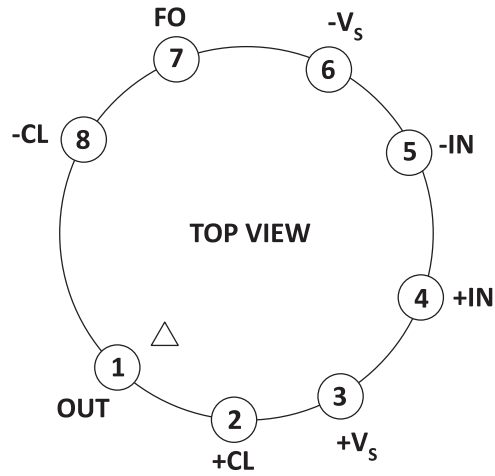

Pin Number	Name	Description
1	OUT	The output. Connect this pin to load and to the feedback resistors.
2	+CL	Connect to the sourcing current limit resistor. Output current flows into/out of these pins through R_{CL+} . The output pin and the load are connected to the other side of R_{CL+} .
3	+Vs	The positive supply rail.
4	+IN	The non-inverting input.
5	-IN	The inverting input.
6	-Vs	The negative supply rail.
7	FO	The foldover current limit. Connect to ground if desired. See 'Current Limiting' section.
8	-CL	Connect to the sinking current limit resistor. Output current flows into/out of these pins through R_{CL-} . The output pin and the load are connected to the other side of R_{CL-} .

SPECIFICATIONS

Specifications of the standard PA12 apply to the PA12H with the exception of the temperature range extensions

1. The operating and storage temperature ABSOLUTE MAXIMUM RATINGS extend to +200°C.
2. Static and dynamic tests are performed at +125°C as shown in SG 2 and SG 5 of the military PA12M data sheet.
3. Additional tests at $T_C = 200^\circ\text{C}$:
 - A. Quiescent current = 100mA max at $\pm V_S = 45$.
 - B. Voltage swing = $\pm V_S - 4$ ($I_O = 1A$, $\pm V_S = 15$)

GENERAL CONSIDERATIONS

The primary aim of the PA12H is to provide a reasonable level of power output at a minimum cost. To achieve this end, full dynamic tests are performed up to 125°C, with only minimal 100% testing at 200°C. This approach saves nearly an order of magnitude over the cost of a fully tested long life product, but does require recognition of two limitations.

First, input parameters such as voltage offset and bias current are not tested above 125°C. This could lead to accuracy problems if the PA12H is used as a precision computational element. Solutions to this limitation include contacting the factory regarding additional testing at higher temperatures or using high temperature small signal amplifiers for computational tasks.

The second limitation of life span requires the PA12H to be used in short term applications. This requirement is mandated by the low cost design concept. At 200°C component degradation is nearly as severe during storage as during actual operation. This must be taken into account when scheduling actual implementation of the finished package.

Please consult the PA12 data sheet for basic information on this amplifier; the PA12M data sheet for details on +125°C tests, and Power Operational Amplifier handbook section "General Operating Considerations," for recommendations on supplies, stability, heatsinks and bypassing.

PACKAGE OPTIONS

PACKAGE STYLE CE

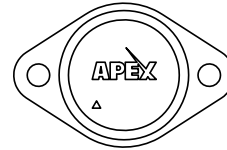
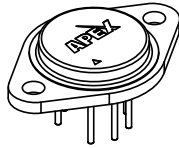

Ordinate dimensions for CAD layout

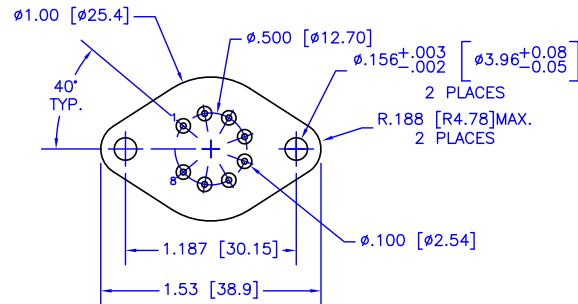
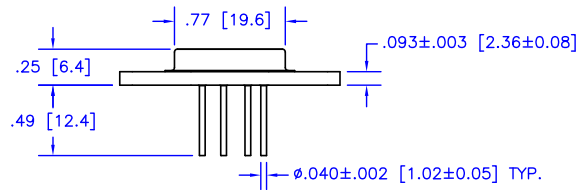
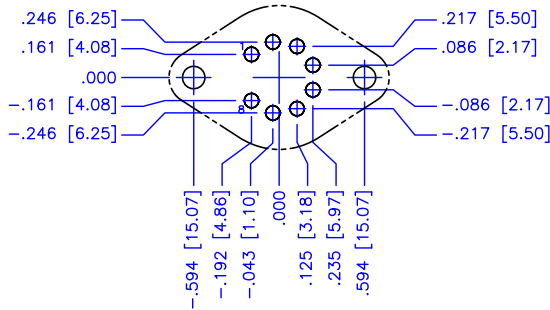

NOTES:

1. Dimensions are inches & [mm].
2. Triangle printed on lid denotes pin 1.
3. Header flatness within pin circle is .0005" TIR, max.
4. Header flatness between mounting holes is .0015" TIR, max.
5. Standard pin material: Solderable nickel-plated Alloy 52.
6. Header material: Nickel-plated cold-rolled steel.
7. Welded hermetic package seal
8. Isolation: 500 VDC any pin to case.
9. Package weight: .53 oz [15 g]

NEED TECHNICAL HELP? CONTACT APEX SUPPORT!

For all Apex Microtechnology product questions and inquiries, call toll free 800-546-2739 in North America. For inquiries via email, please contact apex.support@apexanalog.com. International customers can also request support by contacting their local Apex Microtechnology Sales Representative. To find the one nearest to you, go to www.apexanalog.com

IMPORTANT NOTICE

Apex Microtechnology, Inc. has made every effort to insure the accuracy of the content contained in this document. However, the information is subject to change without notice and is provided "AS IS" without warranty of any kind (expressed or implied). Apex Microtechnology reserves the right to make changes without further notice to any specifications or products mentioned herein to improve reliability. This document is the property of Apex Microtechnology and by furnishing this information, Apex Microtechnology grants no license, expressed or implied under any patents, mask work rights, copyrights, trademarks, trade secrets or other intellectual property rights. Apex Microtechnology owns the copyrights associated with the information contained herein and gives consent for copies to be made of the information only for use within your organization with respect to Apex Microtechnology integrated circuits or other products of Apex Microtechnology. This consent does not extend to other copying such as copying for general distribution, advertising or promotional purposes, or for creating any work for resale.

APEX MICROTECHNOLOGY PRODUCTS ARE NOT DESIGNED, AUTHORIZED OR WARRANTED TO BE SUITABLE FOR USE IN PRODUCTS USED FOR LIFE SUPPORT, AUTOMOTIVE SAFETY, SECURITY DEVICES, OR OTHER CRITICAL APPLICATIONS. PRODUCTS IN SUCH APPLICATIONS ARE UNDERSTOOD TO BE FULLY AT THE CUSTOMER OR THE CUSTOMER'S RISK.

Apex Microtechnology, Apex and Apex Precision Power are trademarks of Apex Microtechnology, Inc. All other corporate names noted herein may be trademarks of their respective holders.