

## *FET Input Operational Amplifier*

RoHS  
COMPLIANT

### FEATURES

- Low Bias Current — FET Input
- Protected Output Stage — Thermal Shutoff
- Excellent Linearity — Class A/B Output
- Wide Supply Range —  $\pm 12V$  to  $\pm 50V$
- High Output Current —  $\pm 5A$  Peak



### APPLICATIONS

- Motor, Valve, and Actuator Control
- Magnetic Deflection Circuits up to 4A
- Power Transducers up to 100 kHz
- Temperature Control up to 180W
- Programmable Power Supplies up to 90V
- Audio Amplifiers up to 60W RMS

### DESCRIPTION

The PA07 is a high voltage, high output current operational amplifier designed to drive resistive, inductive and capacitive loads. For optimum linearity, especially at low levels, the output stage is biased for class A/B operation using a thermistor compensated base-emitter voltage multiplier circuit. A thermal shutoff circuit protects against overheating and minimizes heatsink requirements for abnormal operating conditions. The safe operating area (SOA) can be observed for all operating conditions by selection of user programmable current limiting resistors. Both amplifiers are internally compensated for all gain settings. For continuous operation under load, a heatsink of proper rating is recommended.

This hybrid circuit utilizes thick film (cermet) resistors, ceramic capacitors and semiconductor chips to maximize reliability, minimize size and give top performance. Ultrasonically bonded aluminum wires provide reliable interconnections at all operating temperatures. The 8-pin TO-3 package is hermetically sealed and electrically isolated. The use of compressible washers and/or improper mounting torque will void the product warranty. Please see Application Note 1, "General Operating Considerations."

TYPICAL CONNECTION

Figure 1: Typical Connection

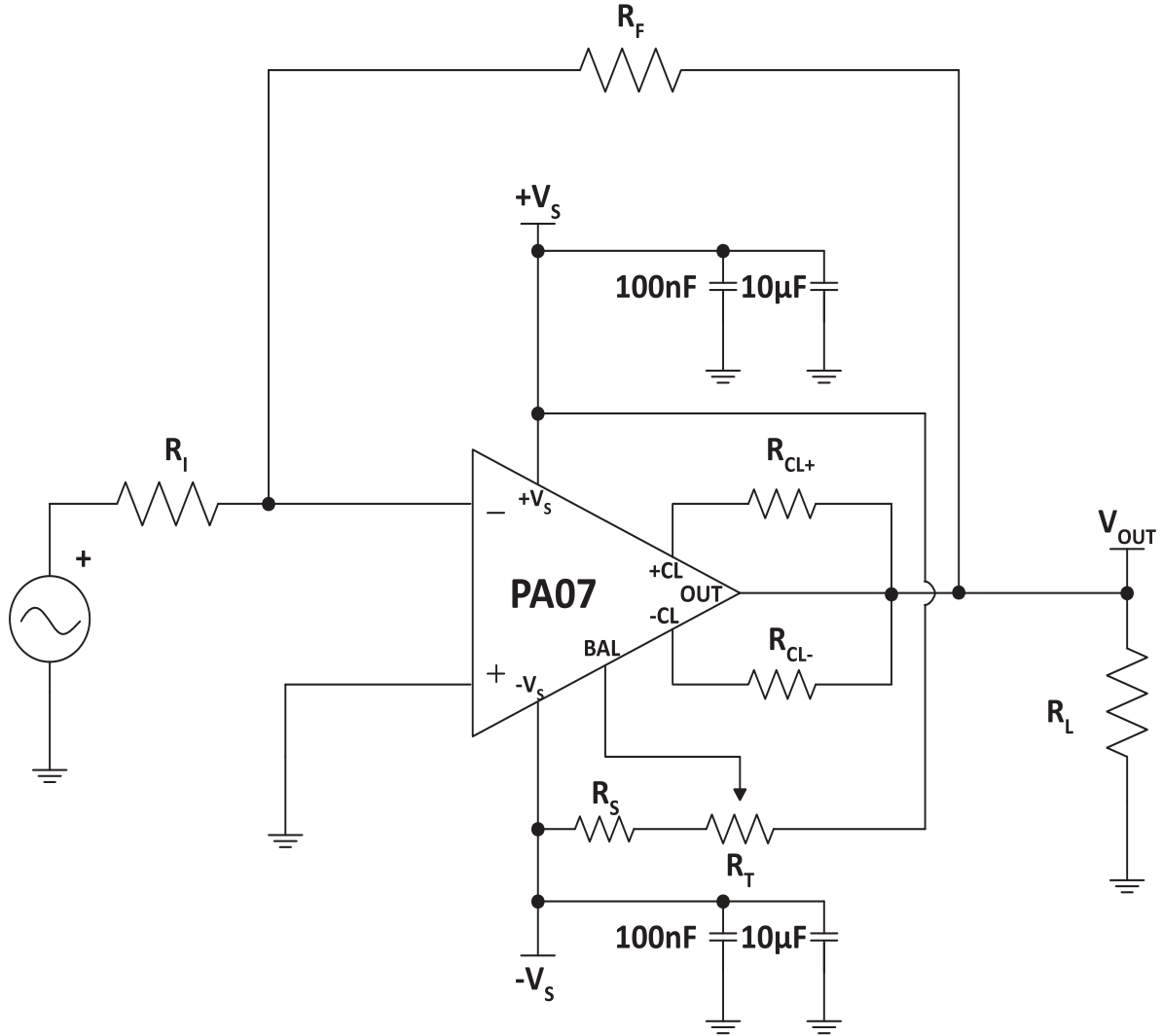

**Note:** Input offset voltage trim optional.  $R_T = 10\text{ k}\Omega\text{ MAX}$

**PINOUT AND DESCRIPTION TABLE**

Figure 2: External Connections

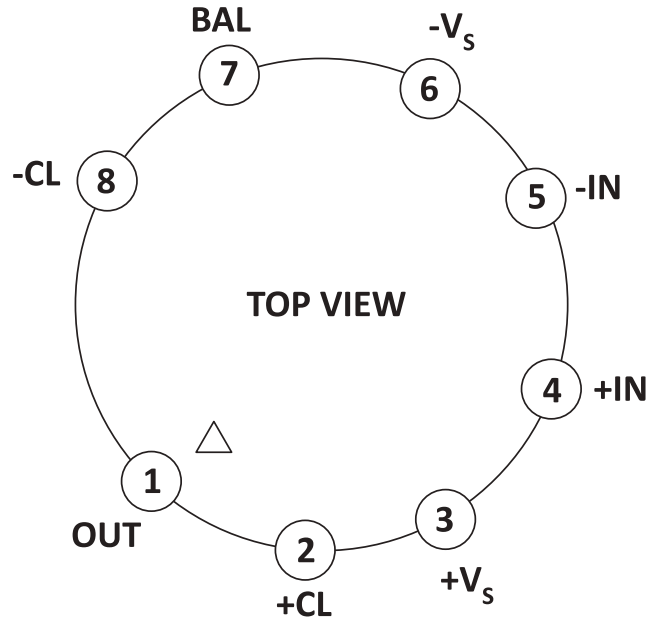

Pin Number	Name	Description
1	OUT	The output. Connect this pin to load and to the feedback resistors.
2	+CL	Connect to the current limit resistor. Output current flows into/out of these pins through $R_{CL}$ . The output pin and the load are connected to the other side of $R_{CL+}$ .
3	+Vs	The positive supply rail.
4	+IN	The non-inverting input.
5	-IN	The inverting input.
6	-Vs	The negative supply rail.
7	BAL	Balance Control pin. Adjusts voltage offset. See applicable section.
8	-CL	Connect to the current limit resistor. Output current flows into/out of these pins through $R_{CL}$ . The output pin and the load are connected to the other side of $R_{CL-}$ .

**SPECIFICATIONS**

The power supply voltage for all specifications is the TYP rating unless otherwise noted as a test condition.

**ABSOLUTE MAXIMUM RATINGS**

Parameter	Symbol	Min	Max	Units
Supply Voltage, total	$+V_S$ to $-V_S$		100	V
Output Current, within SOA	$I_O$		5	A
Power Dissipation, internal <sup>1</sup>	$P_D$		67	W
Input Voltage, differential	$V_{IN(Diff)}$		$\pm 50$	V
Input Voltage, common mode	$V_{cm}$		$\pm V_S$	V
Temperature, pin solder, 10s max.			350	°C
Temperature, junction <sup>1</sup>	$T_J$		200	°C
Temperature Range, storage		-65	+150	°C
Operating Temperature Range, case	$T_C$	-55	+125	°C

1. Long term operation at the maximum junction temperature will result in reduced product life. Derate internal power dissipation to achieve high MTTF.

**CAUTION** The internal substrate contains beryllia (BeO). Do not break the seal. If accidentally broken, do not crush, machine, or subject to temperatures in excess of 850°C to avoid generating toxic fumes.

**INPUT**

Parameter	Test Conditions	PA07			PA07A			Units
		Min	Typ	Max	Min	Typ	Max	
Offset Voltage, initial	$T_C = 25^\circ\text{C}$		0.5	$\pm 2$		$\pm 0.25$	$\pm 0.5$	mV
Offset Voltage vs. Temperature	Full temp range		10	30		5	10	$\mu\text{V}/^\circ\text{C}$
Offset Voltage vs. Supply	$T_C = 25^\circ\text{C}$		8			*		$\mu\text{V}/\text{V}$
Offset Voltage vs. Power	Full temp range		20			10		$\mu\text{V}/\text{W}$
Bias Current, initial <sup>1</sup>	$T_C = 25^\circ\text{C}$		5	50		3	10	pA
Bias Current vs. Supply	$T_C = 25^\circ\text{C}$		0.01			*		pA/V
Offset Current, initial <sup>1</sup>	$T_C = 25^\circ\text{C}$		2.5	50		1.5	10	pA
Input Impedance, DC	$T_C = 25^\circ\text{C}$		$10^{11}$			*		$\Omega$
Input Capacitance	$T_C = 25^\circ\text{C}$		4			*		pF
Common Mode Voltage Range <sup>2</sup>	Full temp range	$\pm V_S - 10$			*			V
Common Mode Rejection, DC	Full temp range, $V_{CM} = \pm 20\text{V}$		120			*		dB

1. Doubles for every 10°C of temperature increase.
2.  $+V_S$  and  $-V_S$  denote the positive and negative supply rail respectively. Total  $V_S$  is measured from  $+V_S$  to  $-V_S$ .

**GAIN**

Parameter	Test Conditions	PA07			PA07A			Units
		Min	Typ	Max	Min	Typ	Max	
Open Loop @ 15 Hz	$T_C = 25^\circ\text{C}$ , $R_L = 15\ \Omega$	89	95		*	*		dB
Gain Bandwidth Product @ 1 MHz	$T_C = 25^\circ\text{C}$ , $R_L = 15\ \Omega$		1.3			*		MHz
Power Bandwidth	$T_C = 25^\circ\text{C}$ , $R_L = 15\ \Omega$		18			*		kHz
Phase Margin	Full temp range, $R_L = 15\ \Omega$		70			*		°

**OUTPUT**

Parameter	Test Conditions	PA07			PA07A			Units
		Min	Typ	Max	Min	Typ	Max	
Voltage Swing <sup>1</sup>	Full temp range, $I_O = 5\text{A}$	$\pm V_S - 5$			*			V
Voltage Swing <sup>1</sup>	Full temp range, $I_O = 2\text{A}$	$\pm V_S - 5$			*			V
Voltage Swing <sup>1</sup>	Full temp range, $I_O = 90\text{mA}$	$\pm V_S - 5$			*			V
Current, peak	$T_C = 25^\circ\text{C}$	5			*			A
Settling Time to 0.1%	$T_C = 25^\circ\text{C}$ , 2V step		1.5			*		$\mu\text{s}$
Slew Rate	$T_C = 25^\circ\text{C}$		5			*		V/ $\mu\text{s}$
Capacitive Load, unity gain	Full temp range,			1			*	nF
Capacitive Load, gain>4	Full temp range,			SOA			*	

1.  $+V_S$  and  $-V_S$  denote the positive and negative supply rail respectively. Total  $V_S$  is measured from  $+V_S$  to  $-V_S$ .

**POWER SUPPLY**

Parameter	Test Conditions	PA07			PA07A			Units
		Min	Typ	Max	Min	Typ	Max	
Voltage	Full temp range	$\pm 12$	$\pm 35$	$\pm 50$	*	*	*	V
Current, quiescent	$T_C = 25^\circ\text{C}$		18	30		*	*	mA

# PA07 • PA07A



## THERMAL

Parameter	Test Conditions	PA07			PA07A			Units
		Min	Typ	Max	Min	Typ	Max	
Resistance, AC, junction to case <sup>1</sup>	F>60 Hz		1.9	2.1		*	*	°C/W
Resistance, DC, junction to case	F<60 Hz		2.4	2.6		*	*	°C/W
Resistance, junction to air			30			*		°C/W
Temperature Range, case	Meets full range specs	-25	25	+85	*	*	*	°C

1. Rating applies if the output current alternates between both output transistors at a rate faster than 60 Hz.

**Note:** \*The specification of PA07A is identical to the specification for PA07 in applicable column to the left.

TYPICAL PERFORMANCE GRAPHS

Figure 3: Power Derating

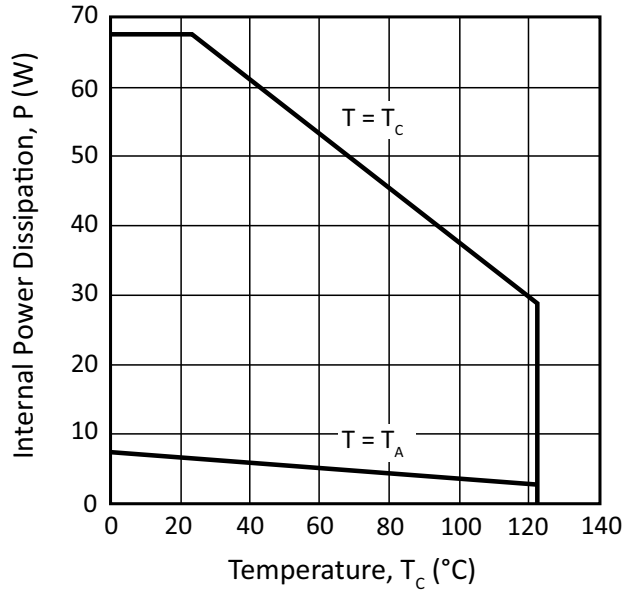

Figure 4: Bias Current

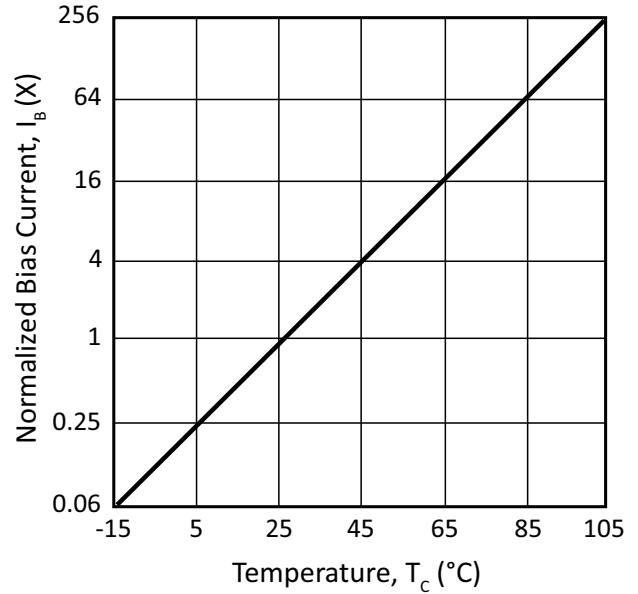

Figure 5: Small Signal Response

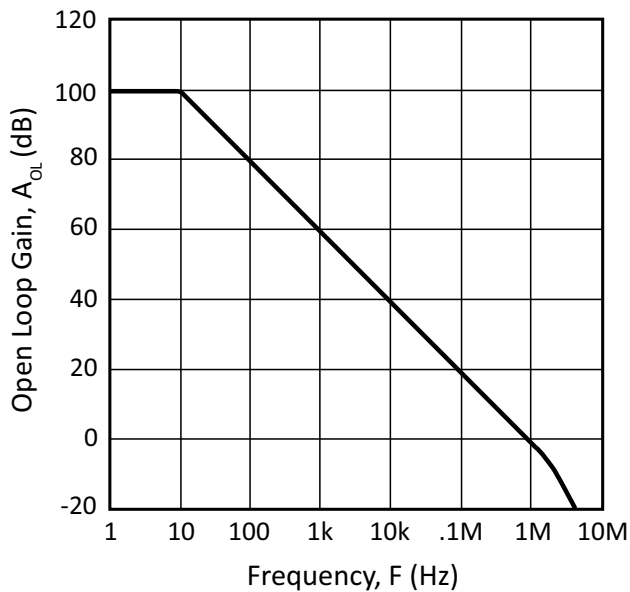

Figure 6: Phase Response

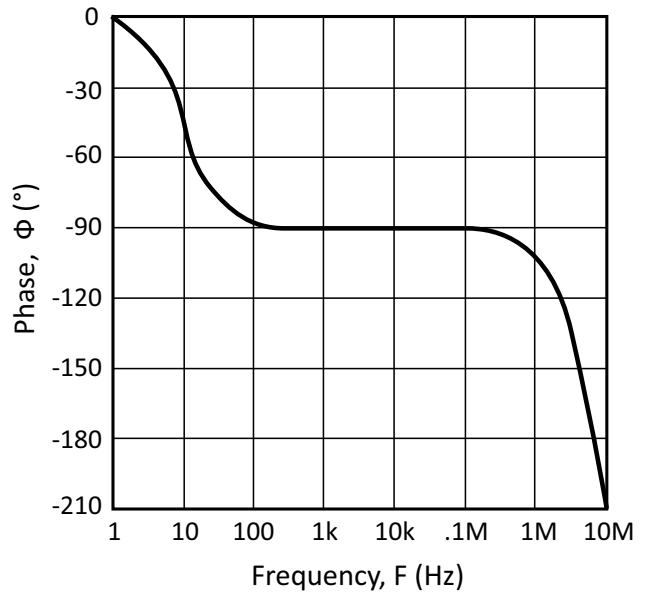

Figure 7: Current Limit

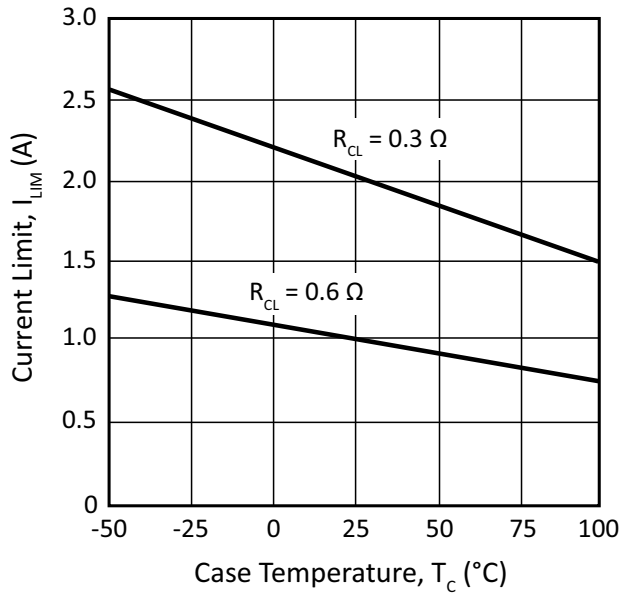

Figure 8: Power Response

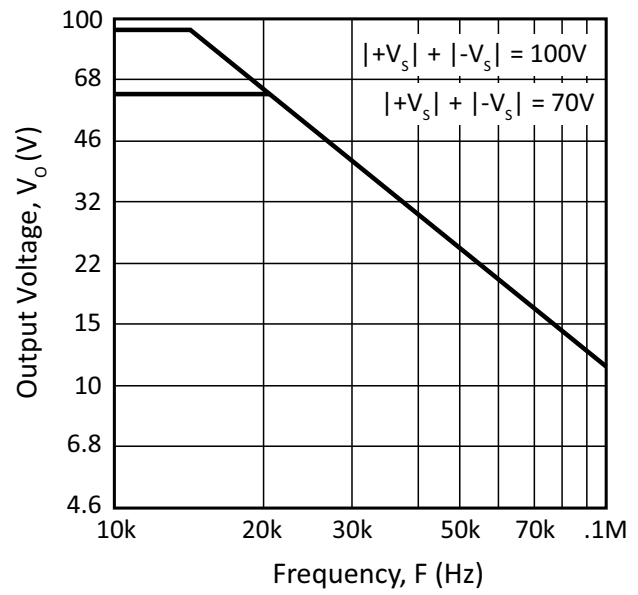

Figure 9: Common Mode Rejection

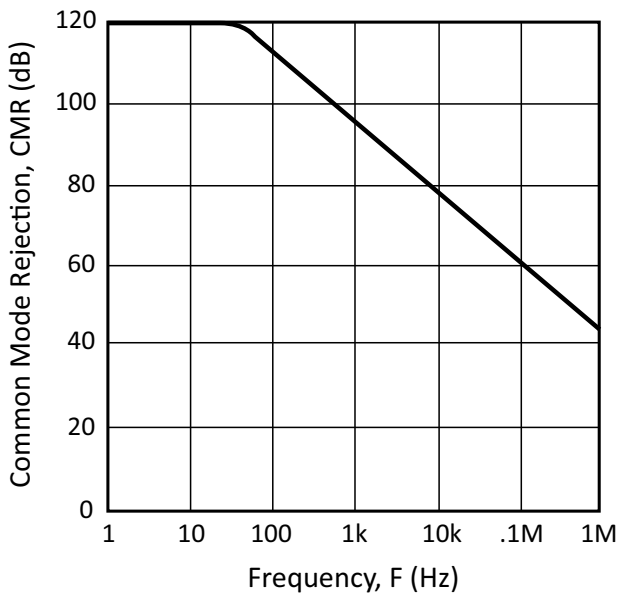

Figure 10: Pulse Response

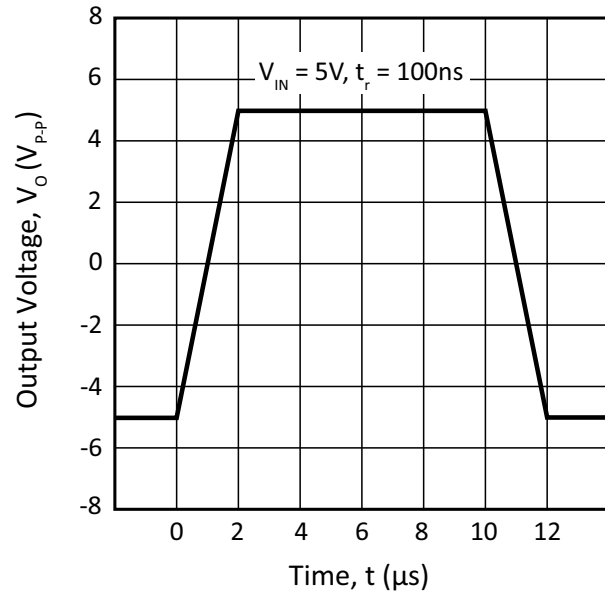



Figure 11: Input Noise

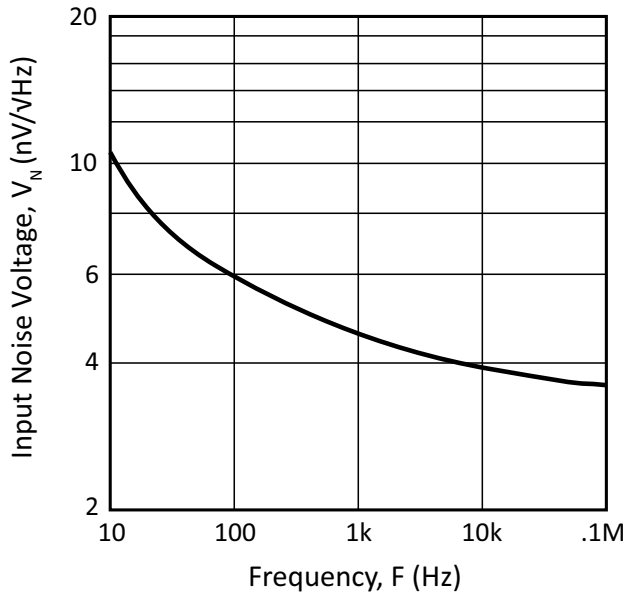

Figure 12: Harmonic Distortion

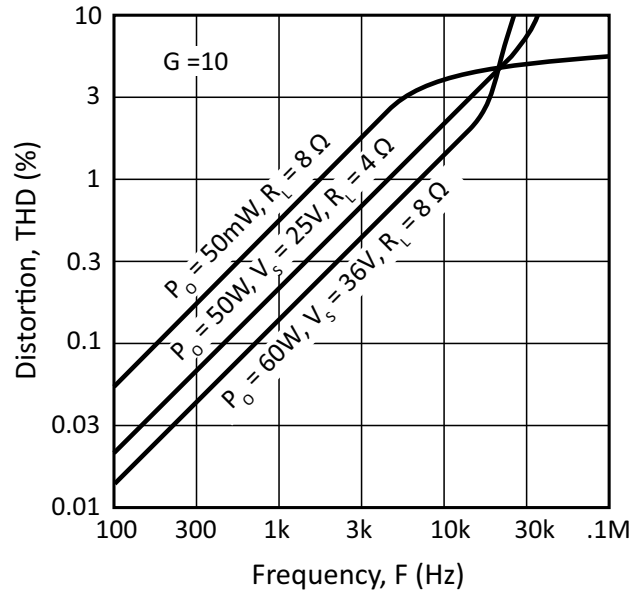

Figure 13: Quiescent Current

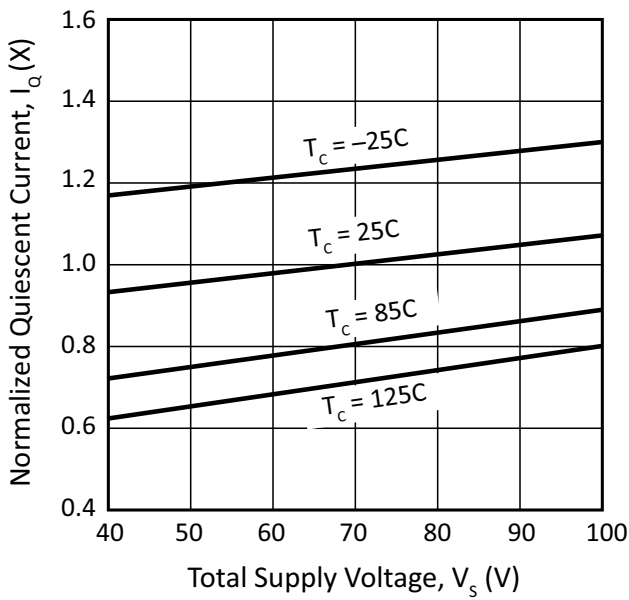
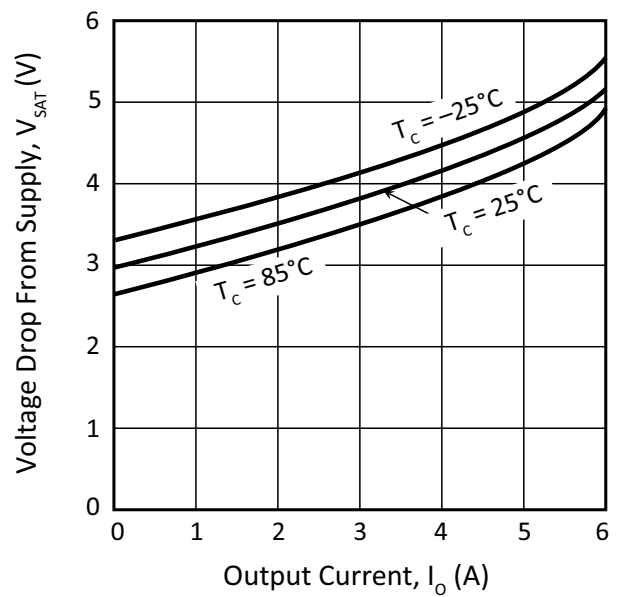

Figure 14: Output Voltage Swing



**SAFE OPERATING AREA (SOA)**

The output stage of most power amplifiers has three distinct limitations:

1. The current handling capability of the wire bonds.
2. The second breakdown effect which occurs whenever the simultaneous collector current and collector-emitter voltage exceed specified limits.
3. The junction temperature of the output transistors.

The SOA curves combine the effect of these limits. For a given application, the direction and magnitude of the output current should be calculated or measured and checked against the SOA curves. This is simple for resistive loads but more complex for reactive and EMF generating loads. However, the following guidelines may save extensive analytical efforts.

1. For DC outputs, especially those resulting from fault conditions, check worst case stress levels against the SOA graph.

Make sure the load line does not cross the 0.5ms limit and that excursions beyond any other second breakdown line do not exceed the time label, and have a duty cycle of no more than 10%.

A Spice type analysis can be very useful in that a hardware setup often calls for instruments or amplifiers with wide common mode rejection ranges. Please refer to Application Notes, AN01 and AN22 for detailed information regarding SOA considerations.

2. The amplifier can handle any reactive or EMF generating load and short circuits to the supply rail or common if the current limits are set as follows at  $T_C = 85^\circ\text{C}$ :

$\pm V_S$	Short to $\pm V_S$ C, L, or EMF Load	Short to Common
50V	0.21A	0.61A
40V	0.3A	0.87A
30V	0.46A	1.4A
20V	0.87A	2.5A
15V	1.4A	4.0A

These simplified limits may be exceeded with further analysis using the operating conditions for a specific application.

3. The output stage is protected against transient flyback. However, for protection against sustained, high energy flyback, external fast-recovery diodes should be used.

Figure 15: SOA

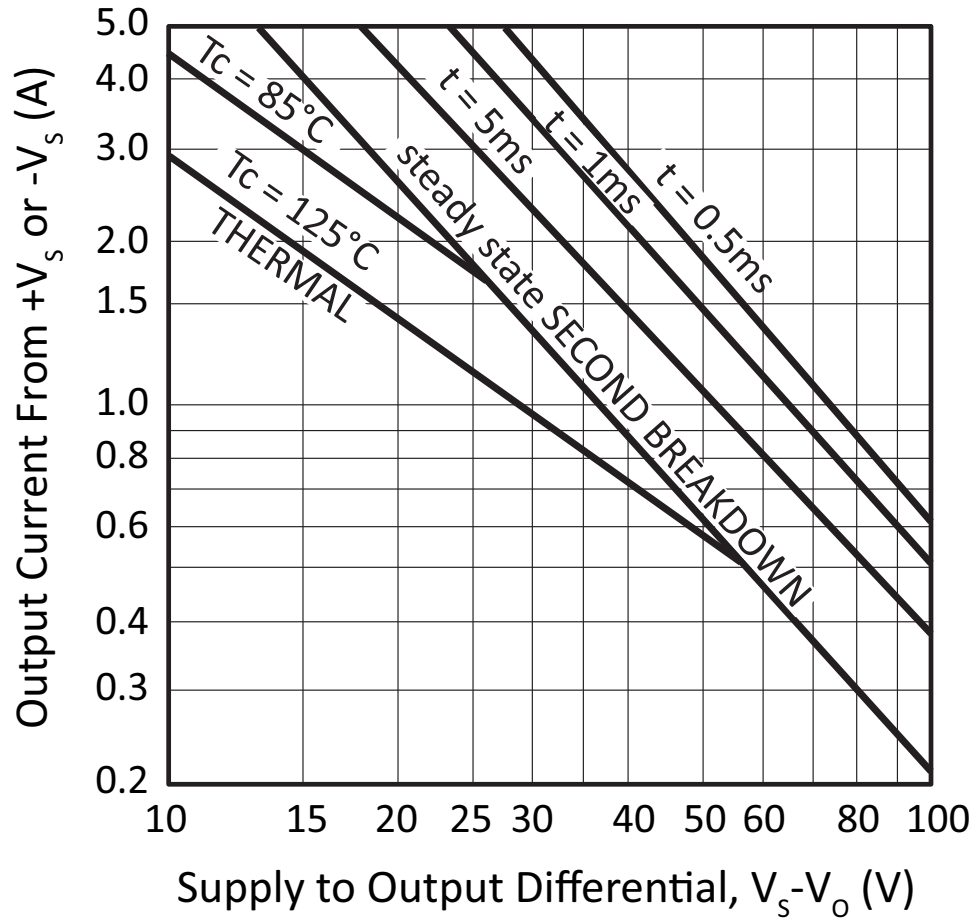

**GENERAL**

Please read Application Note 1 “General Operating Considerations” which covers stability, supplies, heat sinking, mounting, current limit, SOA interpretation, and specification interpretation. Visit [www.apexanalog.com](http://www.apexanalog.com) for Apex Microtechnology’s complete Application Notes library, Technical Seminar Workbook, and Evaluation Kits.

**TYPICAL APPLICATION**

Position is sensed by the differentially connected photo diodes, a method that negates the time and temperature variations of the optical components. Off center positions produce an error current which is integrated by the op amp circuit, driving the system back to center position. A momentary switch contact forces the system out of lock and then the integrating capacitor holds drive level while both diodes are in a dark state. When the next index point arrives, the lead network of  $C_L$  and  $R_L$  optimize system response by reducing overshoot. The very low bias current of the PA07 augments performance of the integrator circuit.

**Figure 16: Typical Application**

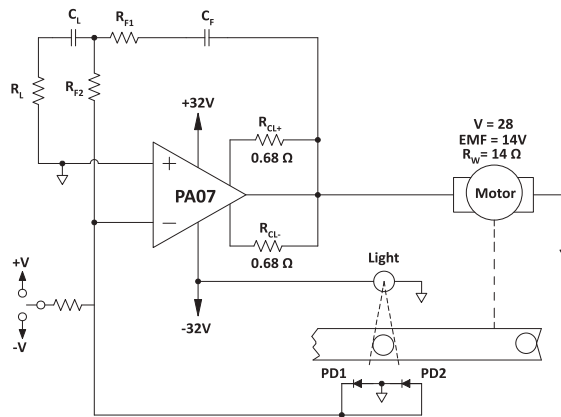

**Note:** Negates optoelectronic instabilities; Lead network minimizes overshoot; Sequential Position Control

**THERMAL SHUTDOWN PROTECTION**

The thermal protection circuit shuts off the amplifier when the substrate temperature exceeds approximately 150°C. This allows heatsink selection to be based on normal operating conditions while protecting the amplifier against excessive junction temperature during temporary fault conditions.

Thermal protection is a fairly slow-acting circuit and therefore does not protect the amplifier against transient SOA violations (areas outside of the  $T_C = 25^\circ\text{C}$  boundary). It is designed to protect against short-term fault conditions that result in high power dissipation within the amplifier. If the conditions that cause thermal shutdown are not removed, the amplifier will oscillate in and out of shutdown. This will result in high peak power stresses, will destroy signal integrity and reduce the reliability of the device.

## CURRENT LIMIT

Proper operation requires the use of two current limit resistors, connected as shown in the external connections diagram. The minimum value for  $R_{CL}$  is  $0.12 \Omega$ ; however, for optimum reliability it should be set as high as possible. Refer to Application Note 1 and 9 for current limit adjust details.

$$R_{CL}(\Omega) = \frac{0.65V}{I_{LIM}(A)}$$

**PACKAGE OPTIONS**

Part Number	Apex Package Style	Description
PA07	CE	8-pin TO-3
PA07A	CE	8-pin TO-3

**PACKAGE STYLE CE**

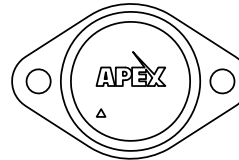
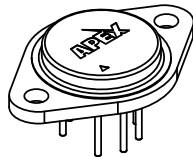

**Ordinate dimensions for CAD layout**

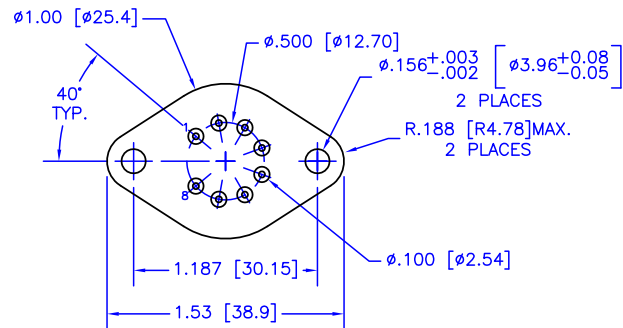
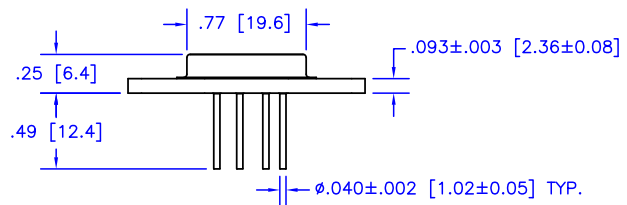
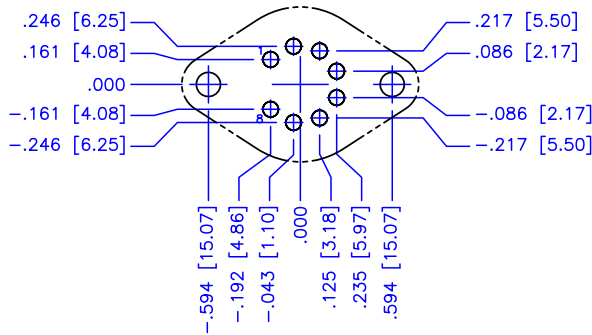

**NOTES:**

1. Dimensions are inches & [mm].
2. Triangle printed on lid denotes pin 1.
3. Header flatness within pin circle is .0005" TIR, max.
4. Header flatness between mounting holes is .0015" TIR, max.
5. Standard pin material: Solderable nickel-plated Alloy 52.
6. Header material: Nickel-plated cold-rolled steel.
7. Welded hermetic package seal
8. Isolation: 500 VDC any pin to case.
9. Package weight: .53 oz [15 g]

---

## **NEED TECHNICAL HELP? CONTACT APEX SUPPORT!**

For all Apex Microtechnology product questions and inquiries, call toll free 800-546-2739 in North America. For inquiries via email, please contact [apex.support@apexanalog.com](mailto:apex.support@apexanalog.com). International customers can also request support by contacting their local Apex Microtechnology Sales Representative. To find the one nearest to you, go to [www.apexanalog.com](http://www.apexanalog.com)

---

### IMPORTANT NOTICE

Apex Microtechnology, Inc. has made every effort to insure the accuracy of the content contained in this document. However, the information is subject to change without notice and is provided "AS IS" without warranty of any kind (expressed or implied). Apex Microtechnology reserves the right to make changes without further notice to any specifications or products mentioned herein to improve reliability. This document is the property of Apex Microtechnology and by furnishing this information, Apex Microtechnology grants no license, expressed or implied under any patents, mask work rights, copyrights, trademarks, trade secrets or other intellectual property rights. Apex Microtechnology owns the copyrights associated with the information contained herein and gives consent for copies to be made of the information only for use within your organization with respect to Apex Microtechnology integrated circuits or other products of Apex Microtechnology. This consent does not extend to other copying such as copying for general distribution, advertising or promotional purposes, or for creating any work for resale.

APEX MICROTECHNOLOGY PRODUCTS ARE NOT DESIGNED, AUTHORIZED OR WARRANTED TO BE SUITABLE FOR USE IN PRODUCTS USED FOR LIFE SUPPORT, AUTOMOTIVE SAFETY, SECURITY DEVICES, OR OTHER CRITICAL APPLICATIONS. PRODUCTS IN SUCH APPLICATIONS ARE UNDERSTOOD TO BE FULLY AT THE CUSTOMER OR THE CUSTOMER'S RISK.

Apex Microtechnology, Apex and Apex Precision Power are trademarks of Apex Microtechnology, Inc. All other corporate names noted herein may be trademarks of their respective holders.