



Pulse Width Modulation Amplifier

FEATURES

- LOW COST
- HIGH VOLTAGE - 450 VOLTS
- HIGH OUTPUT CURRENT - 20 AMPS
- 9kW OUTPUT CAPABILITY
- VARIABLE SWITCHING FREQUENCY
- IGBT FULL BRIDGE OUTPUT

APPLICATIONS

- BRUSH MOTOR CONTROL
- MRI
- MAGNETIC BEARINGS
- CLASS D SWITCHMODE AMPLIFIER

GENERAL DESCRIPTION

The MSA260 is a surface mount constructed PWM amplifier that provides a cost effective solution in many industrial applications. The MSA260 offers outstanding performance that rivals many much more expensive hybrid components. The MSA260 is a complete PWM amplifier including an oscillator, comparator, error amplifier, current limit comparators, 5V reference, a smart controller and a full bridge IGBT output circuit. The switching frequency is user programmable up to 50 kHz. The MSA260 is built on a thermally conductive but electrically insulating substrate that can be mounted to a heatsink.

EQUIVALENT CIRCUIT DIAGRAM

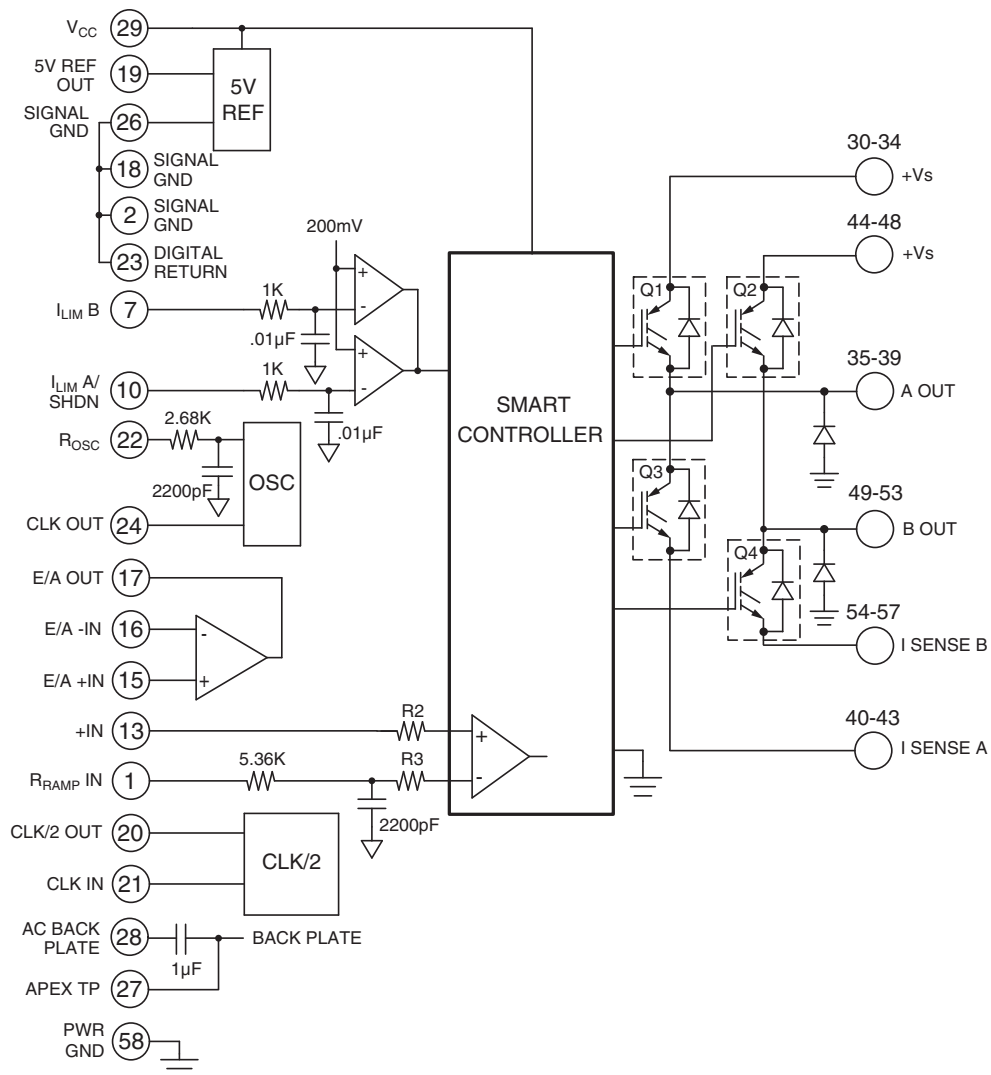

CHARACTERISTICS AND SPECIFICATIONS

ABSOLUTE MAXIMUM RATINGS

Parameter	Symbol	Min	Max	Units
SUPPLY VOLTAGE	V_s		450	V
SUPPLY VOLTAGE	V_{CC}		16	V
OUTPUT CURRENT, peak, within SOA			30	A
POWER DISSIPATION, internal, DC (Note 3)			250	W
SIGNAL INPUT VOLTAGES			5.4	V
TEMPERATURE, pin solder, 10s			225	°C
TEMPERATURE, junction (Note 2)			150	°C
TEMPERATURE RANGE, storage		-40	105	°C
OPERATING TEMPERATURE, case		-40	85	°C

SPECIFICATIONS

Parameter	Test Conditions (Note 1)	Min	Typ	Max	Units
ERROR AMPLIFIER					
OFFSET VOLTAGE	Full temperature range			9	mV
BIAS CURRENT, initial (Note 3)	Full temperature range			500	nA
OFFSET CURRENT, initial	Full temperature range			150	nA
COMMON MODE VOLTAGE RANGE, pos.	Full temperature range	0		4	V
SLEW RATE	Full temperature range		1		V/μs
OPEN LOOP GAIN	$R_L = 2K\Omega$		96		dB
UNITY GAIN BANDWIDTH			1		MHz
CLOCK					
LOW LEVEL OUTPUT VOLTAGE	Full temperature range			0.2	V
HIGH LEVEL OUTPUT VOLTAGE	Full temperature range	4.8			V
RISE TIME			7		nS
FALL TIME			7		nS
BIAS CURRENT, pin 22	Full temperature range			0.6	μA
5V REFERENCE OUTPUT					
VOLTAGE		4.85		5.15	V
LOAD CURRENT				2	mA
OUTPUT (Note 4)					
$V_{CE(ON)}$, each active IGBT	$I_{CE} = 15A$			2.25	V
CURRENT, continuous	$V_s = 400V, F = 22kHz$			20	A
CURRENT, peak	1mS, $V_s = 400V, F = 22kHz$			30	A
FLYBACK DIODE					
CONTINUOUS CURRENT			44	20	A
FORWARD VOLTAGE	$I_F = 15A$		200	1.5	V
REVERSE RECOVERY	$I_F = 15A$	0.2	0.7	150	nS

Parameter	Test Conditions (Note 1)	Min	Typ	Max	Units
POWER SUPPLY					
VOLTAGE, V_s		5	400	450	V
VOLTAGE, V_{cc}		14	15	16	V
CURRENT, V_s , quiescent	22kHz switching		9	28	mA
CURRENT, V_{cc} , quiescent	22kHz switching			18	mA
CURRENT, V_{cc} , shutdown				10	mA
THERMAL					
RESISTANCE, DC, junction to case	Full temperature range			1	°C/W
RESISTANCE, junction to air	Full temperature range			14	°C/W
TEMPERATURE RANGE, case		-40		85	°C

NOTES:

1. Unless otherwise noted: $T_c = 25^\circ\text{C}$, $V_{cc} = 15\text{V}$, $V_s = 400\text{V}$, $F = 22\text{kHz}$.
2. Long term operation at the maximum junction temperature will result in reduced product life. Derate internal power dissipation to achieve high MTBF.
3. Each of the two output transistors on at any one time can dissipate 125W.
4. Maximum specification guaranteed but not tested.

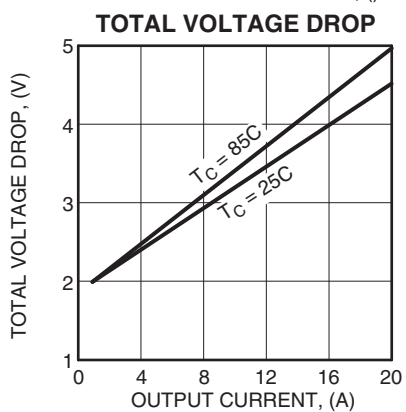
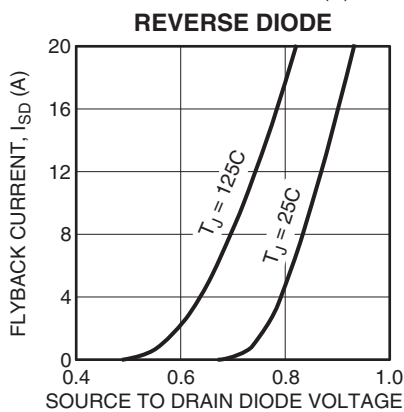
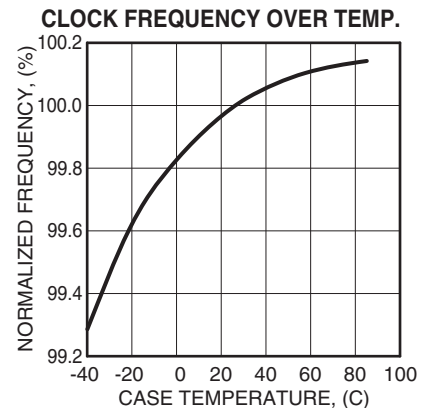
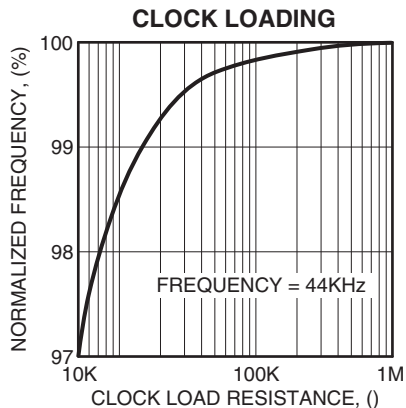
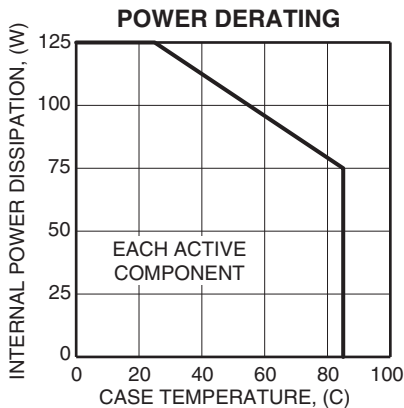

DUTY CYCLE VS. ANALOG INPUT

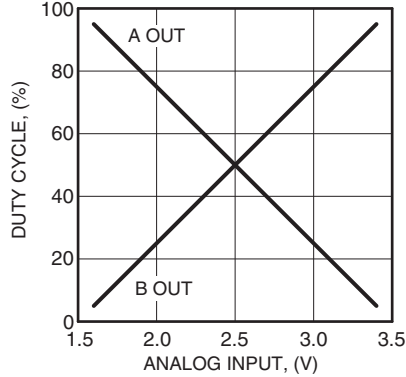

V_{CC} QUIESCENT CURRENT

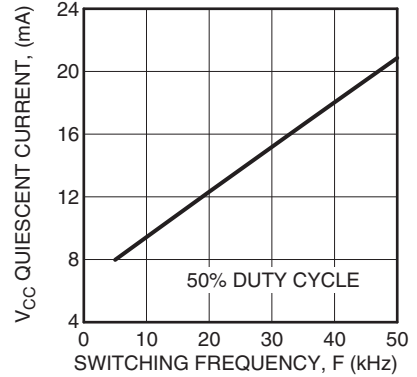

V_{CC} QUIESCENT CURRENT

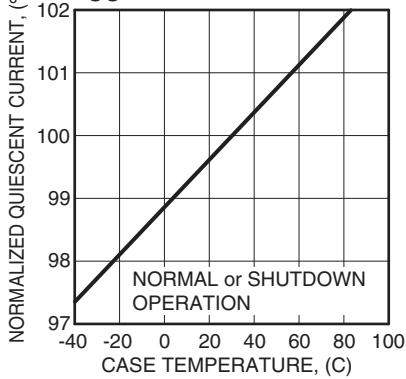

V_S QUIESCENT CURRENT

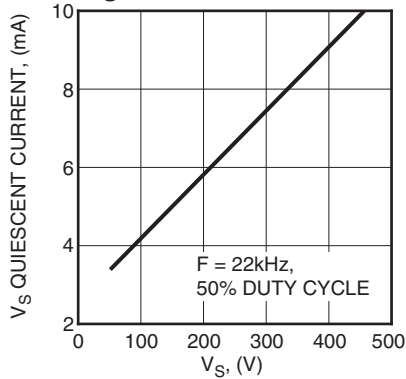

V_S QUIESCENT CURRENT vs. FREQUENCY

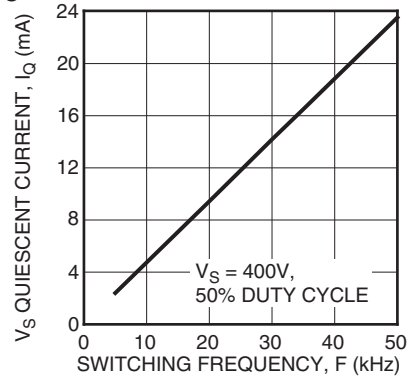

EXTERNAL CONNECTIONS

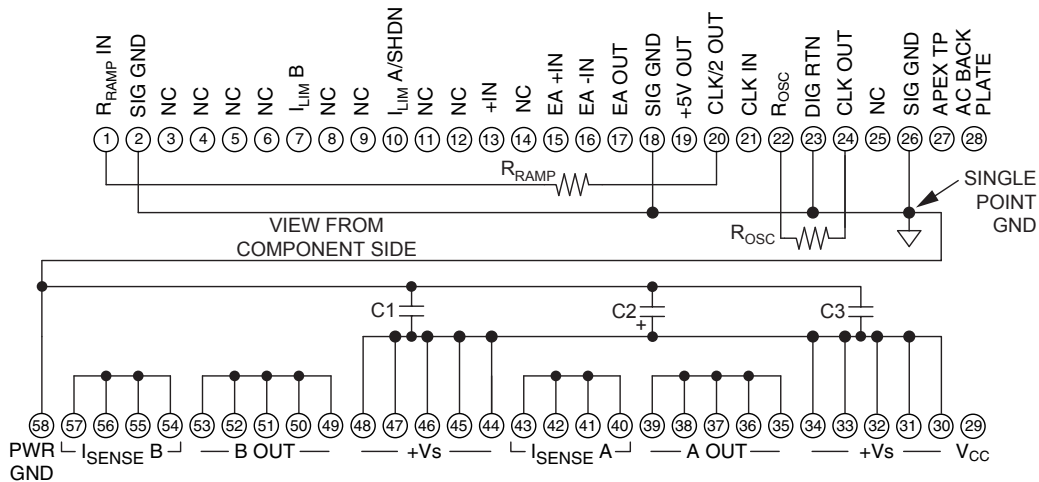

- NOTES:
- C2 IS ELECTROLYTIC $\geq 10\mu\text{F}$ PER AMP OUTPUT CURRENT
 - C1,3 HIGH QUALITY CERAMIC $\geq 1.0\mu\text{F}$
 - ALL +V_S MUST BE TIED TOGETHER
 - ALL SIG GND PINS MUST BE TIED TOGETHER
 - SINGLE POINT GROUND @ PIN 26

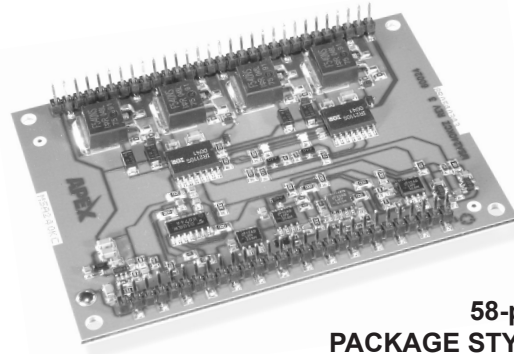

TYPICAL APPLICATION TORQUE MOTOR CONTROL

With the addition of a few external components the MSA260 becomes a motor torque controller. In the MSA260 the source terminal of each low side IGBT driver is brought out for current sensing via R_sA and R_sB . A1 is a differential amplifier that amplifies the difference in currents of the two half bridges. This signal is fed into the internal error amplifier that mixes the current signal and the control signal. The result is an input signal to the MSA260 that controls the torque on the motor.

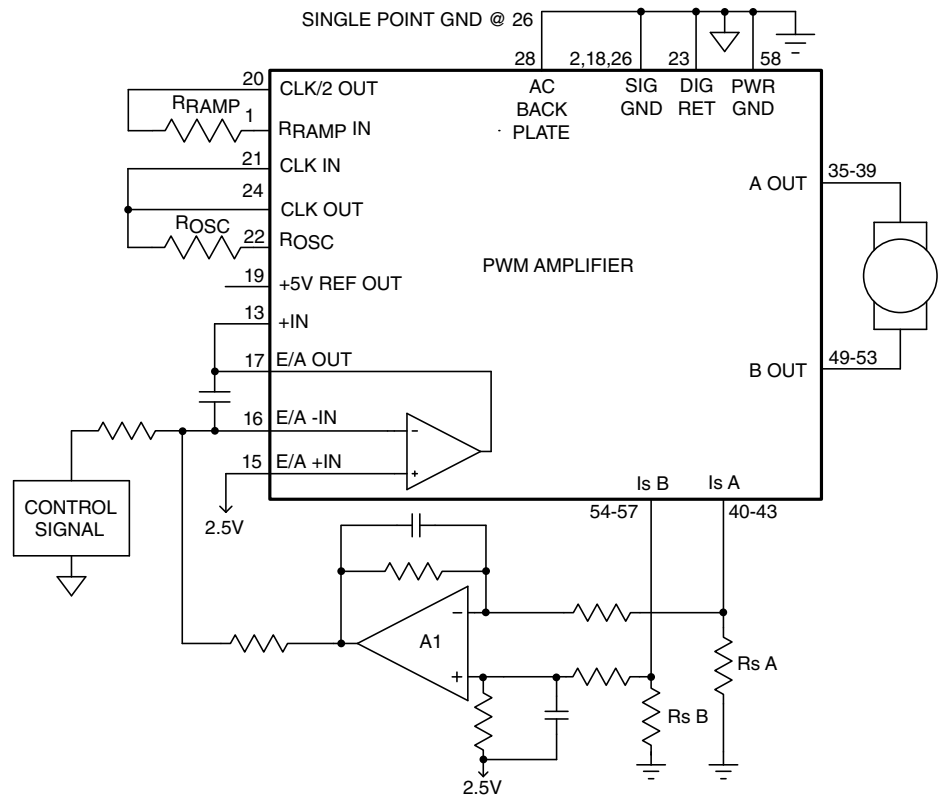

GENERAL

Please read Application Note 30 "PWM Basics". Refer also to Application Note 1 "General Operating Considerations" for helpful information regarding power supplies, heat sinking, mounting, SOA interpretation, and specification interpretation. Visit www.apexanalog.com for design tools that help automate tasks such as calculations for stability, internal power dissipation, current limit, heat sink selection, Apex Microtechnology's complete Application Notes library, Technical Seminar Workbook and Evaluation Kits.

OSCILLATOR

The MSA260 includes a user frequency programmable oscillator. The oscillator determines the switching frequency of the amplifier. The switching frequency of the amplifier is 1/2 the oscillator frequency. Two resistor values must be chosen to properly program the switching frequency of the amplifier. One resistor, R_{OSC} , sets the oscillator frequency. The other resistor, R_{RAMP} , sets the ramp amplitude. In all cases the ramp voltage will oscillate between 1.5V and 3.5V. See Figure 1. If an external oscillator is applied use the equations to calculate R_{RAMP} .

To program the oscillator, R_{OSC} is given by:

$$R_{OSC} = (1.32 \times 10^8 / F) - 2680$$

where F is the desired **switching frequency** and:

$$R_{RAMP} = 2 \times R_{OSC}$$

Use 1% resistors with 100ppm drift (RN55C type resistors, for example). Maximum **switching frequency** is 50kHz.

Example:

If the desired **switching frequency** is 22kHz then $R_{OSC} = 3.32K$ and $R_{RAMP} = 6.64K$. Choose the closest standard 1% values: $R_{OSC} = 3.32K$ and $R_{RAMP} = 6.65K$ or simply use two of selected R_{OSC} in series for R_{RAMP} .

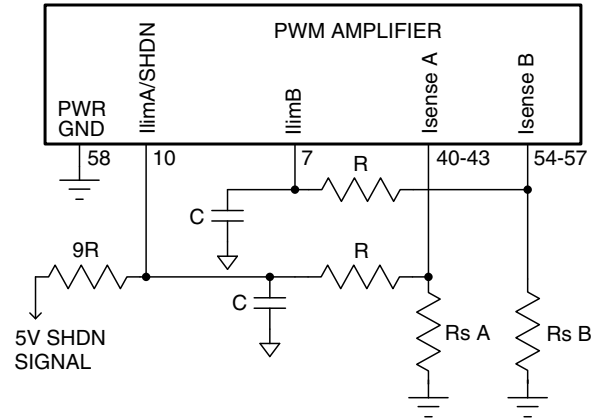

FIGURE 1. EXTERNAL OSCILLATOR CONNECTIONS

SHUTDOWN

The MSA260 output stage can be turned off with a shutdown command voltage applied to Pin 10 as shown in Figure 2. The shutdown signal is OR'ed with the current limit signal and simply overrides it. As long as the shutdown signal remains high the output will be off.

CURRENT SENSING

The low side drive transistors of the MSA260 are brought out for sensing the current in each half bridge. A resistor from each sense line to PWR GND (pin 58) develops the current sense voltage. Choose R and C such that the time constant is equal to 10 periods of the selected switching frequency. The internal current limit comparators trip at 200mV. Therefore, current limit occurs at $I = 0.2/R_{SENSE}$ for each half bridge. See Figure 2. Accurate milliohm power resistors are required and there are several sources for these listed in the Accessories Vendors section of the Databook.

POWER SUPPLY BYPASSING

Bypass capacitors to power supply terminals $+V_S$ must be connected physically close to the pins to prevent local parasitic oscillation and overshoot. All $+V_S$ must be connected together. Place and electrolytic capacitor of at least 10 μ F per output amp required midpoint between these sets of pins. In addition place a ceramic capacitor 1.0 μ F or greater directly at **each** set of pins for high frequency bypassing. V_{CC} is bypassed internally.

GROUNDING AND PCB LAYOUT

Switching amplifiers combine millivolt level analog signals and large amplitude switching voltages and currents with fast rise times. As such grounding is crucial. Use a single point ground at SIG GND (pin 26). Connect signal ground pins 2 and 18 directly to the single point ground on pin 26. Connect the digital return pin 23 directly to pin 26 as well. Connect PWR GND pin 58 also to pin 26. Connect AC BACKPLATE pin 28 also to the single point ground at pin 26. Connect the ground terminal of the V_{CC} supply directly to pin 26 as well. Make sure no current from the load return to PWR GND flows in the analog signal ground. Make sure that the power portion of the PCB layout does not pass over low-level analog signal traces on the opposite side of the PCB. Capacitive coupling through the PCB may inject switching voltages into the analog signal path. Further, make sure that the power side of the PCB layout does not come close to the analog signal side. Fast rising output signal can couple through the trace-to-trace capacitance on the same side of the PCB.

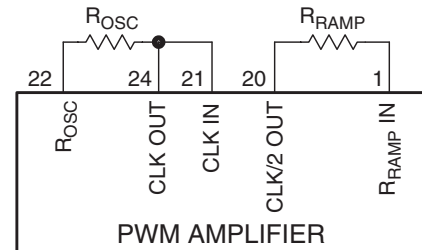

FIGURE 2. CURRENT LIMIT WITH OPTIONAL SHUTDOWN

DETERMINING THE OUTPUT STATE

The input signal is applied to +IN (Pin 13) and varies from 1.5 to 3.5 volts, zero to full scale. The ramp also varies over the same range. When:

$$\text{Ramp} > +IN \quad A_{\text{OUT}} > B_{\text{OUT}}$$

The output duty cycle extremes vary somewhat with switching frequency and are internally limited to approximately 5% to 95% at 10kHz and 7% to 93% at 50kHz.

CALCULATING INTERNAL POWER DISSIPATION

Detailed calculation of internal power dissipation is complex but can be approximated with simple equations. Conduction loss is given by:

$$W = I \cdot 2.5 + I^2 \cdot 0.095$$

where I = output current

Switching loss is given by:

$$W = 0.00046 \cdot I \cdot V_{\text{supply}} \cdot F_{\text{switching}} \text{ (in kHz)}$$

Combine these two losses to obtain total loss. Calculate heatsink ratings and case temperatures as would be done for a linear amplifier. For calculation of junction temperatures, assume half the loss is dissipated in each of two switches:

$$T_j = T_a + W_{\text{total}} \cdot R_{\theta\text{hs}} + 1/2 W_{\text{total}} \cdot R_{\theta\text{jc}}, \text{ where:}$$

$R_{\theta\text{hs}}$ = heatsink rating

$R_{\theta\text{jc}}$ = junction-to-case thermal resistance of the MSA260.

The SOA typical performance graphs below show performance with the MSA260 mounted with thermal grease on the Apex Microtechnology HS26. The Free Air graph assumes vertical orientation of the heatsink and no obstruction to air flow in an ambient temperature of 30°C. The other two graphs show performance with two levels of forced air. Note that air velocity is given in linear feet per minute. As fans are rated in cubic delivery capability, divide the cubic rating by the square area this air flows through to find velocity. As fan delivery varies with static pressure, these calculations are approximations, and heatsink ratings vary with amount of power dissipated, there is no substitute for temperature measurements on the heatsink in the center of the amplifier footprint as a final check.

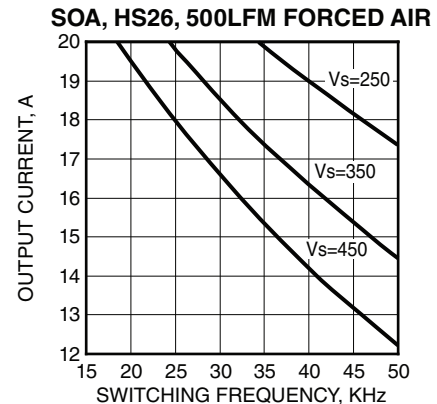
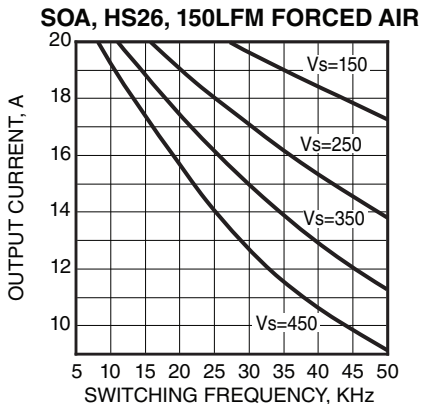
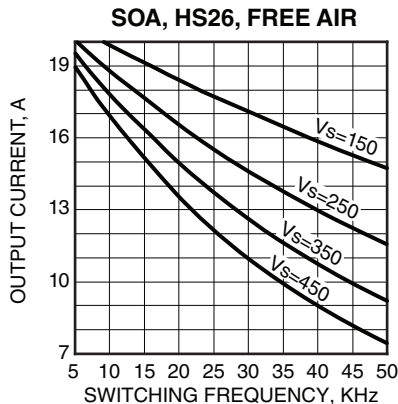

NEED TECHNICAL HELP? CONTACT APEX SUPPORT!

For all Apex Microtechnology product questions and inquiries, call toll free 800-546-2739 in North America.

For inquiries via email, please contact apex.support@apexanalog.com.

International customers can also request support by contacting their local Apex Microtechnology Sales Representative.

To find the one nearest to you, go to www.apexanalog.com

IMPORTANT NOTICE

Apex Microtechnology, Inc. has made every effort to insure the accuracy of the content contained in this document. However, the information is subject to change without notice and is provided "AS IS" without warranty of any kind (expressed or implied). Apex Microtechnology reserves the right to make changes without further notice to any specifications or products mentioned herein to improve reliability. This document is the property of Apex Microtechnology and by furnishing this information, Apex Microtechnology grants no license, expressed or implied under any patents, mask work rights, copyrights, trademarks, trade secrets or other intellectual property rights. Apex Microtechnology owns the copyrights associated with the information contained herein and gives consent for copies to be made of the information only for use within your organization with respect to Apex Microtechnology integrated circuits or other products of Apex Microtechnology. This consent does not extend to other copying such as copying for general distribution, advertising or promotional purposes, or for creating any work for resale.

APEX MICROTECHNOLOGY PRODUCTS ARE NOT DESIGNED, AUTHORIZED OR WARRANTED TO BE SUITABLE FOR USE IN PRODUCTS USED FOR LIFE SUPPORT, AUTOMOTIVE SAFETY, SECURITY DEVICES, OR OTHER CRITICAL APPLICATIONS. PRODUCTS IN SUCH APPLICATIONS ARE UNDERSTOOD TO BE FULLY AT THE CUSTOMER OR THE CUSTOMER'S RISK.

Apex Microtechnology, Apex and Apex Precision Power are trademarks of Apex Microtechnology, Inc. All other corporate names noted herein may be trademarks of their respective holders.